

B (2x)  
(L+R)

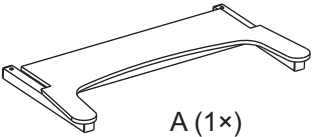

A (1x)

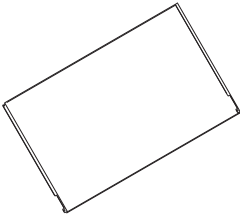

C (1x)



D (2x)



E (2x)



F (2x)



G (4x)



H (8x)



I (4x)



J (2x)



K (4x)



M (2x)



N (2x)



SW 6

1

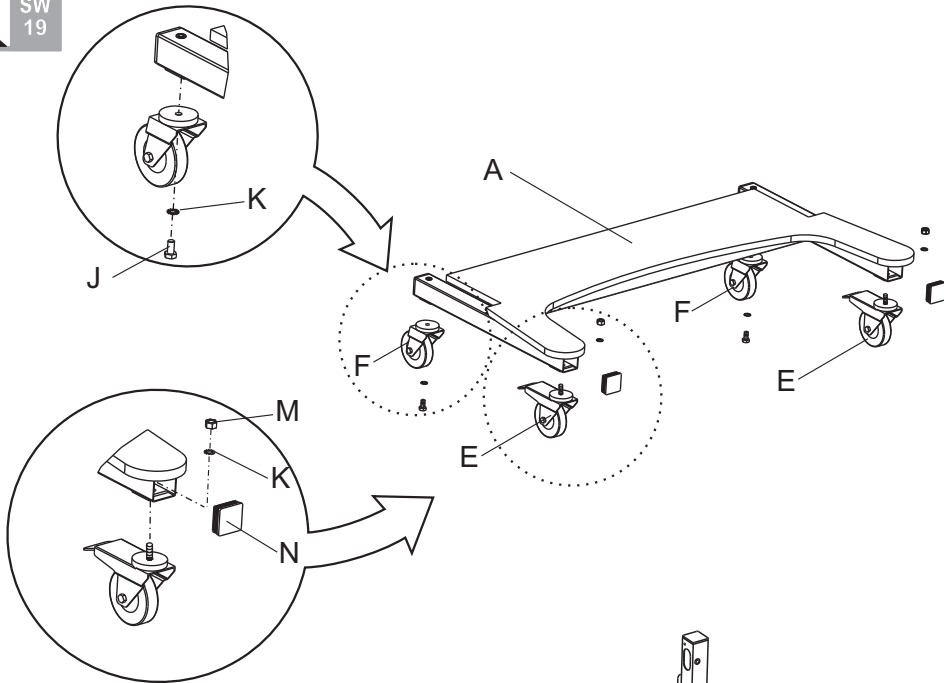

3

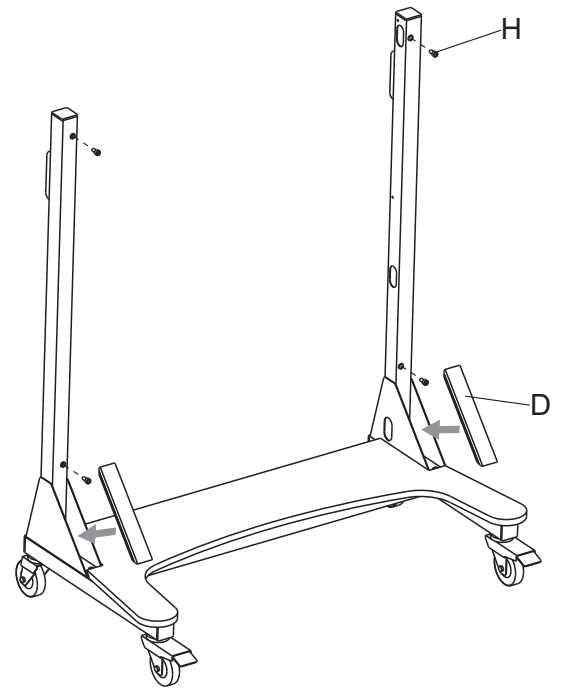

2

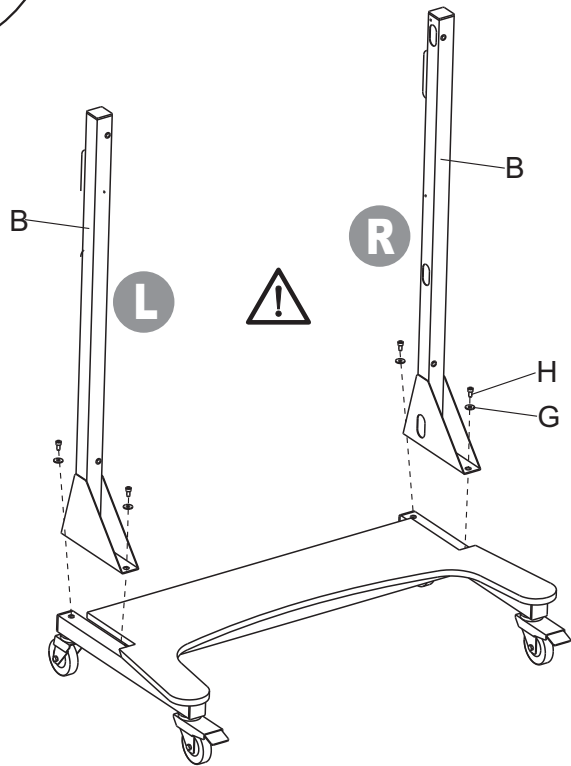

4

